



# A WORLD OF IDEAS



**TECHNOLOGIES FOR SUSTAINABLE  
COTTON TEXTILE MANUFACTURING**

**A World of Ideas:**  
**Technologies for Sustainable  
Cotton Textile Manufacturing**



*® The Seal of Cotton is a registered trademark of Cotton Incorporated.*

Photographs used by kind permission of Benninger (page 6), Gaston Systems (page 9), Monforts (page 10), Fong's (pages 23 and 24), Strahm Hi-Tex Systems (page 26), Kuans Micro-Auto (page 32), and Adaptive Control (page 33).

© 2009 Cotton Incorporated.  
All rights reserved; America's Cotton Producers and Importers

The statements, recommendations, and suggestions contained herein are based on experiments and information believed to be reliable only with regard to the products and/or processes involved at the time. No guarantee is made of their accuracy, however, and the information is given without warranty as to its accuracy or reproducibility either expressed or implied, and does not authorize use of the information for purposes of advertisement or product endorsement or certification. Likewise, no statement contained herein shall be construed as a permission or recommendation for the use of any information, product, or process that may infringe any existing patents. The use of trade names does not constitute endorsement of any product mentioned, nor is permission granted to use the name Cotton Incorporated or any of its trademarks in conjunction with the products involved.

# Contents

Introduction.....	1
Process .....	3
Cold Pad Batch Preparation and Dyeing .....	5
Continuous Processing of Knits.....	6
Two-Stage Preparation of Wovens .....	7
Combined Scour and Bleach for Yarns and Knits .....	8
Foam Dyeing, Finishing, and Coating .....	9
Pad/Dry vs. Pad/Dry/Pad/Steam.....	10
Right First Time Dyeing .....	11
Chemicals and Dyes.....	13
Cationization for Salt-Free Dyeing .....	15
High-Fixation Reactive Dyeing with Reduced Salt.....	16
Enzyme Treatment.....	17
Size Recovery and Recycling via Ultrafiltration .....	18
Pre-reduced Liquid Dyes.....	19
Pigment Pad Application .....	20
Equipment.....	21
Low-Liquor-Ratio Jet Dyeing Machines .....	23
Low-Liquor-Ratio Package Dyeing.....	24
Caustic Recovery and Reuse.....	25
Insulation of Dyeing, Drying, and Tenter Machines.....	26
Solar Heating of Water .....	27
Systems, Control, and Management.....	29
Automatic Dye and Chemical Dispensing .....	31
Advanced Equipment and Process Control.....	32
Various System Approaches to Reduce WEC.....	33
Empowered Environmental Teams .....	34
Wastewater Treatment .....	35
High-Technology Filtration Systems .....	37
Recycling of Internal Process Water .....	38
Use or Sale of Wastewater Treatment Sludge for Fuel.....	39
Physical, Biological, and Activated-Carbon Systems .....	40
Summary Chart .....	41
Vendors .....	45

## Introduction

*We want you to take action.* We hope that you—as companies involved in the global supply chain for the world’s number-one consumer fiber—will consider the ideas in this booklet to improve your cotton business and reduce the environmental footprint in our industry. Cotton Incorporated is committed to helping you achieve these goals.

For over three decades, Cotton Incorporated has been at the forefront of facilitating innovations that help make textile manufacturing more efficient and effective. Today, our work continues with a focus on identifying and promoting strategies to reduce the use of water, energy, and chemicals (WEC) in textile processing. Along with a network of universities, cotton textile manufacturing operations, and equipment and chemical suppliers around the world, Cotton Incorporated is working to help the global textile industry be more environmentally friendly and cost-efficient.

Reduction of the WEC environmental footprint is best achieved in fabric preparation, dyeing, and finishing processes. Water is an especially important focus, because reduction of water use brings corresponding reductions in the energy required to heat water and, to a lesser extent, the amounts of chemicals and dyes used.

### **Industry Survey**

During the winter of 2008–09, in-depth interviews were conducted with more than 40 cotton textile processing companies in regions of China, India, Turkey, Southeast Asia, and the Americas that account for over 75% of global textile processing. We are grateful to the many visionary companies that participated in this study and were willing to share their experiences with proven commercial technologies that can help reduce the WEC footprint in textile manufacturing. These companies manufacture a wide range of woven, knit, denim, and yarn products and have implemented changes in their processes, dyes and chemicals, equipment, and control systems that significantly reduce WEC requirements.

### **Best Technologies to Reduce WEC**

From the industry interviews emerged a short list of 26 practical and effective technologies for reducing the WEC footprint in cotton textile processing. Implementation of these technologies required investments ranging from minor to major. The technologies fall into the following five categories:

1. Process
2. Chemicals and dyes
3. Equipment
4. Systems, control, and management
5. Wastewater treatment

Although each technology has been assigned to a category, some technologies apply to more than one category. These 26 technologies can be employed to varying degrees with piece-dyed wovens, piece-dyed knits, denim, and yarn-dyeing operations.

### Survey Conclusions

The cotton textile industry can reduce the WEC environmental footprint at least 50% by employing technologies currently used in modern plants located in the world's major textile production regions. The plants that are the most advanced in reducing WEC pursue a combination of options, including high-efficiency management practices, process control, special processes, and higher-cost machines especially designed for low use and internal recycling of water and chemicals. Each plant adopts options compatible with its particular product offerings, economic circumstances, environmental regulations, and supply-chain requirements. Achieving these WEC reductions has required plants to learn and adapt to new processes and practices and to implement creative means for ensuring acceptable economic returns. Cooperation throughout the supply chain to retail has been critical to encouraging and supporting these efforts in order to address growing consumer concerns about the environment.

### Using This Booklet

Descriptions of the 26 technologies are organized by the five categories listed above. Each technology is described briefly, with emphasis on commercial operating experience as reported by the companies surveyed.

The survey also assessed the following factors:

- Each technology's potential for reduce the use of water, energy, and chemicals (WEC environmental footprint reduction).
- Each technology's potential impact and current level of implementation.

Survey respondents rated each of these factors as *low* (less than 25%), *moderate* (25% to 50%), or *high* (more than 50%). These results are summarized graphically for each technology on the following scale:

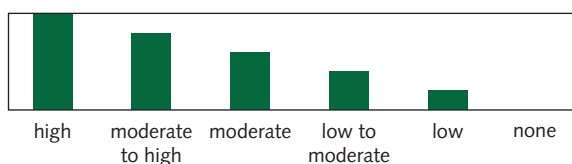

Also shown for each technology are the required economic investment and expected payback time, as estimated from survey data. A chart summarizing the survey results for all 26 technologies is provided on page 41, and contact information for vendors is provided at the end of this booklet.



# Process

Cold Pad Batch Preparation and Dyeing

Continuous Processing of Knits

Two-Stage Preparation of Wovens

Combined Scour and Bleach for Yarns and Knits

Foam Dyeing, Finishing, and Coating

Pad/Dry vs. Pad/Dry/Pad/Steam

Right First Time Dyeing



## Cold Pad Batch Preparation and Dyeing

The cold pad batch (CPB) system uses roller-pad application of highly concentrated chemicals and dyes during fabric preparation and dyeing stages, followed by room-temperature lagging of the impregnated fabric on the beam. Scouring or dyeing actions are accomplished effectively during this low-temperature lag time. Compared with conventional processing, the CPB system reduces reliance on large volumes of heated water for application of chemicals and dyes. Furthermore, no salt is required for reactive dyeing. The classic CPB system has undergone significant changes since its development during the early 1960s, through continuing coordination of research and development on chemicals and dyestuffs, dyehouse control processes, and equipment.

**Environmental Footprint Reduction**

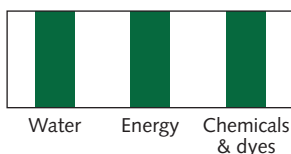

**Industry Survey Response**

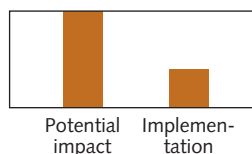

### Commercial Operating Experience

The CPB system is fully proven for preparation and dyeing of wovens and knits, and accounts for a growing percentage of global capacity for wet processing of cotton textiles. Although billions of pounds of fabric have been processed with this technology, there remains great potential for expansion, especially in knits.

In addition to providing large savings in WEC, CPB processing improves knit surface aesthetics—surfaces typically are smoother and cleaner than those of jet-dyed fabrics. Preparation and dyeing processes are a function of time, temperature, and pH. Because CPB processing occurs at room temperature, the reaction takes longer than under the higher temperatures used in jet processing. Although the dwell time for the CPB process is extended, staging of batching rolls in a separate area frees the pad for additional applications.

The share of fabrics processed by CPB is about 2% in Asia and over 30% in Europe and the Americas. Increased adoption of CPB for knits is expected as emphasis on reduction of WEC continues, energy costs increase, and machinery innovations further improve knit handling in continuous processing.



**Investment:** over \$500,000

**Payback:** 2 to 5 years

**Vendors:** Benninger, Erbatech, Goller

## Continuous Processing of Knits

Continuous processing technology, widely adopted for woven fabrics, has now been refined for use with more delicate (tension-sensitive) knitted fabrics. Processes have been developed for continuous scouring, bleaching, mercerizing, de-watering, dyeing, and finishing of flat and tubular knit fabrics. Technologies include advanced chemical and dye application systems, minimum tension provision, creaseless fabric passage, and advances in drive, control, heating, and extraction systems. Continuous processing of knits delivers major reductions in WEC, as well as increased productivity.

**Environmental Footprint Reduction**

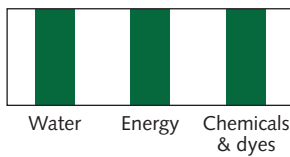

**Industry Survey Response**

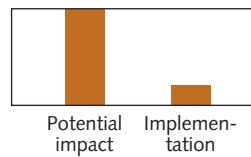

### Commercial Operating Experience

Continuous processing of knits has been available commercially for years, but is used for only a small fraction of all knits. However, interest in continuous processing of knits is increasing, especially because of the potential WEC reductions and cost savings, and as a result of advances in controls and equipment.

Woven fabrics generally are wet processed continuously, especially when the volume of fabric to be processed is high enough to support an economical run time. Even accounting for the water required for sizing and desizing of wovens, continuous wet processing of wovens typically requires less than half as much water as batch-processing of knits.

Continuous processing can reduce processing time and increase productivity more than tenfold over batch processing. Operating costs can be reduced by 30% to 40%. Furthermore, continuous processing tends to provide a cleaner, smoother fabric surface than batch processing. However, to be economical, continuous processing requires larger lot sizes (over 10,000 meters). Adoption of continuous processing will require training, and operators and management will need to gain experience with the technology. Issues to be addressed in continuous processing of knits relate to tension control to maintain fabric weight, quality, and uniformity.

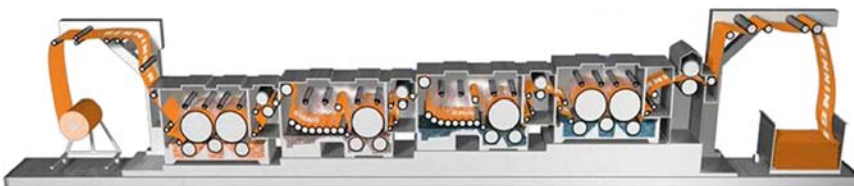

**Investment:** over \$500,000

**Payback:** 2 to 5 years

**Vendors:** Benninger,

Erbatech, Monforts

## Two-Stage Preparation of Wovens

Advances in chemistry have enabled the use of fewer baths for desizing, scouring, and bleaching of cotton, depending on the specific textile product, processing equipment, and final product requirements. The key to success is achieving compatibility of the bath conditions, such as pH, and the chemical components of the bath. Wovens have in the past required a three-stage preparation line (desize, scour, bleach); a two-stage process (desize, bleach) can reduce water requirements substantially and enable reductions in use of chemicals and energy.

**Environmental Footprint Reduction**

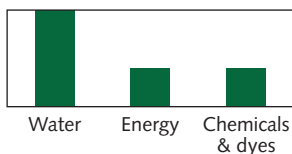

**Industry Survey Response**

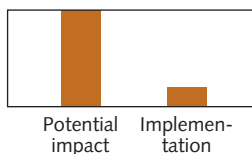

### Commercial Operating Experience

This technology is used in high volume and in a large number of mills for two-stage preparation of wovens. However, considerable opportunity remains for WEC reduction through further optimization and implementation of this technology, with respect to both chemistry and equipment design. In particular, chemical applications need to be developed that will reduce the number of rinses for two-stage processes. The ultimate goal should be a one-stage preparation process for wovens.

Products and technologies to support these process improvements are offered by many chemical companies, especially the major suppliers to the textile industry, and most of them claim various proprietary advantages.

Applications have been most readily adopted for darker and less critical colors, but the technology is not limited to these.

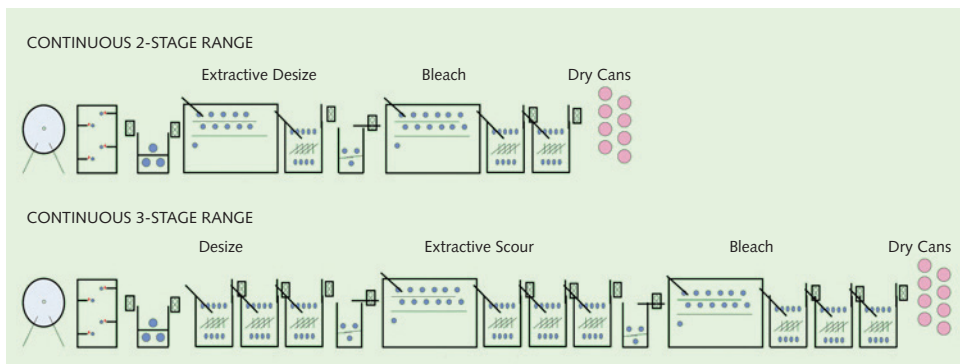

**Investment:** less than \$200,000 to over \$500,000  
**Payback:** within 2 years to over 5 years

**Vendors:** *Chemicals:* BASF, CHT, Dymatic, Huntsman, Innova  
*Equipment:* Benninger, Goller, Morrison

## Combined Scour and Bleach for Yarns and Knits

Advances in chemistry have enabled the use of a single bath, rather than separate baths, for scouring and bleaching of cotton yarns and knits, depending on the specific processing equipment and final product requirements. The key to success is achieving compatibility of the bath conditions, such as temperature and pH, and the chemical components of the bath.

Environmental Footprint Reduction

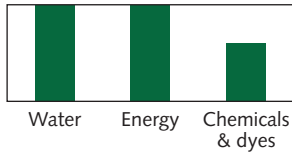

Industry Survey Response

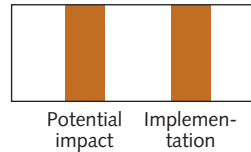

### Commercial Operating Experience

This technology is widely used and is now considered standard practice in most yarn and knit wet-processing mills. No special equipment is necessary, and most major dye and chemical vendors offer formulations that are designed for combined scouring and bleaching.

A mill may encounter some very critical shades, generally light or pale, that still require separate scouring and bleaching, but this is the exception, not the rule.



**Investment:** less than \$200,000

**Payback:** within 2 years

**Vendors:** BASF, Clariant, Dymatic, Huntsman

## Foam Dyeing, Finishing, and Coating

Foam application of process chemicals, in place of conventional systems of dip tanks, sprays, pad mangles, and suction boxes, enables the uniform application of aqueous functional chemistry to cotton fabrics with less than half the water required by conventional systems. Although the technology has been available for many years, major advances in formulation chemistry, foam generation, and application control have been made over the past decade.

**Environmental Footprint Reduction**

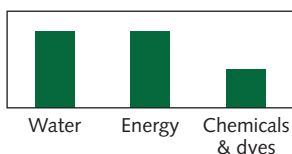

**Industry Survey Response**

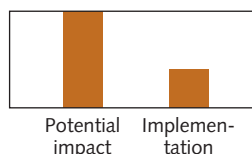

### Commercial Operating Experience

Foam application technology has been commercially available for over 25 years, but implementation was limited until the past 5 to 10 years, during which time mill adoption has increased significantly in efforts to reduce WEC and operating costs. This growth has been supported by advances in foam chemistry and systems from a number of vendors.

Foam systems are used for knits and wovens, including denim, for pigment dyeing, finishing, and coating. The low moisture content of the foam application results in faster drying, enabling a significant increase in production. Because foam places the solution only where required, single-sided or dual-sided applications are possible. For example, in the case of functional finishes, one side of the fabric can be treated to be hydrophobic and the other side to be hydrophilic.

Application of ionic dye systems has been explored but is not yet commercially proven, because of issues with dispersion and foam stability.

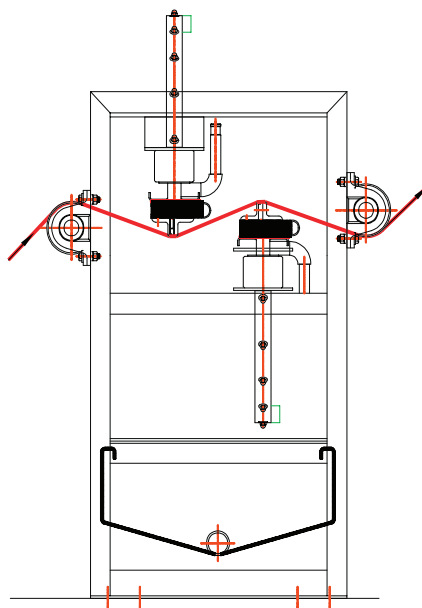

**Investment:** over \$500,000

**Payback:** 2 to 5 years

**Vendors:** Gaston Systems, Stork Prints

## Pad/Dry vs. Pad/Dry/Pad/Steam

This technology is aimed at replacing the conventional continuous pad/dry/pad/steam process typically used for reactive dyeing of most cotton wovens. The new process accomplishes dye application and fixation in a much simpler pad/dry step, without the use of salt, generally by means of controlled, high-humidity drying. This technology offers huge potential savings in WEC and operating cost, as well as gains in productivity.

### Environmental Footprint Reduction

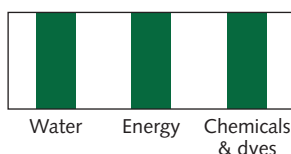

### Industry Survey Response

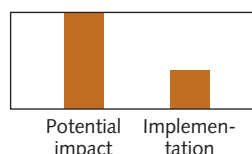

### Commercial Operating Experience

The largest current commercial implementation of this technology is based on the Monforts/DyStar Econtrol technology, equipment, and dyes. Mills report successful operation and achievement of WEC-reduction and cost-reduction goals.

This flexible technology is applicable to both knits and wovens, 100% cotton and cotton blends. The unit can be adapted for preparation, dyeing, and finishing. Quick changeover capabilities allow the machine to be switched from one shade to another in less than ten minutes. No steamer is required for fixation, and dwell times are significantly shorter than with conventional continuous systems.

Growth of this technology has been slow because of the large capital investment required. Some mills have been investigating the possibility of retrofitting existing equipment. The continuing pressure to reduce WEC and operating costs, together with continuing industry exposure to this technology, will likely lead to increased implementation.

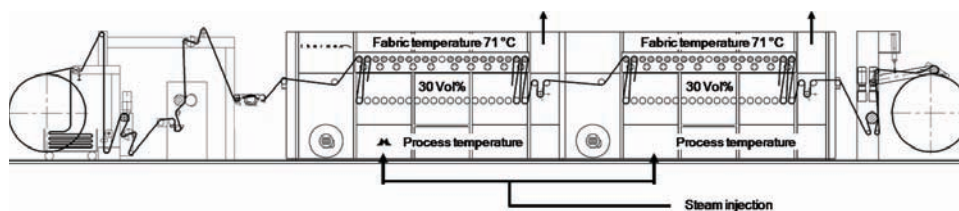

**Investment:** over \$500,000

**Payback:** over 5 years

**Vendors:** DyStar, Monforts

## Right First Time Dyeing

The “right first time” (RFT) approach to dyeing requires management, supervisors, and operators to focus on close measurement and follow-up of all aspects of the production system to ensure that each step is operating as specified. Goal-oriented product specifications are met on first-pass processing, so material is not held in-process for dye additions or rework dyeing. Rapid corrective action is taken when any defect is identified in the process or product. Operator and technical teams define and implement longer-term solutions to more frequently occurring breakdowns or disruptions in the process.

**Environmental Footprint Reduction**

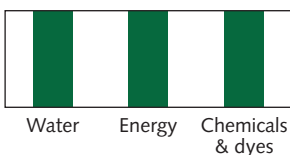

**Industry Survey Response**

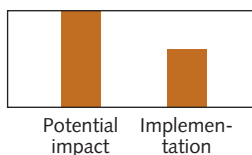

### Commercial Operating Experience

The RFT approach has been used commercially for many years, becoming more common in the mid 1990s. It is well proven, especially for larger-volume, multiple-batch products.

This approach requires a commitment to establishing lab-to-production correlation, color communication between production staff and the customer, and line-operator training. Other requirements are well-maintained equipment, process controls, and a managed dyestuff/chemical inventory. Some mills report achieving RFT with over 95% of dyeings.



**Investment:** less than \$200,000

**Payback:** within 2 years



# Chemicals & Dyes

Cationization for Salt-Free Dyeing

High-Fixation Reactive Dyeing with Reduced Salt

Enzyme Treatment

Size Recovery and Recycling via Ultrafiltration

Pre-reduced Liquid Dyes

Pigment Pad Application



## Cationization for Salt-Free Dyeing

Cationization is the chemical modification of cotton to produce cationic (positively charged) dyeing sites in place of existing hydroxyl (-OH) sites. This enables the cotton to easily attract anionic dyes (direct, fiber reactive, pigment dispersion, and acid) without the need for large quantities of salt. Currently, reactive dyes are used for over 70% of all cotton dyed, and salt requirements have increased to over 20 billion pounds per year.

### Environmental Footprint Reduction

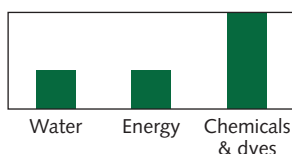

### Industry Survey Response

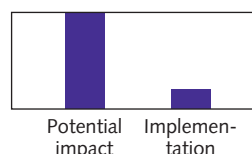

### Commercial Operating Experience

This technology has been available for many years and is being used commercially in a number of mills for dyeing yarns, knits, wovens, and garments. However, implementation remains at a relatively low level, for various reasons:

- Low fixation of cationic agents by exhaust methods can increase chemical and processing costs.
- Cationic cotton requires some modification of existing dyeing procedures.
- Production of seconds may be high until a mill has substantial experience with the process.

Cationization eliminates the salt requirement for reactive dyeing and increases dye color yield. However, application of the cationic agent requires an additional cycle similar to that for a typical reactive dye (though with fewer rinsing steps), and alkali is required for fixation. Dye selection is critical, as some dyes work better with cationic cotton than others. Selection can be limited by requirements for color, depth of shade, and fastness (especially light-fastness). For safety reasons, the cationic agent should be applied in a closed system.

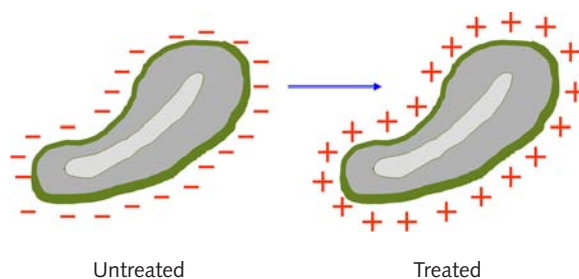

This technology has very high potential impact—the amount of chemicals required to dye cotton textiles can potentially be reduced by as much as 50%. Further research and development continues to refine the application process and improve product quality.

**Investment:** less than \$200,000

**Vendors:** Dow, Evonik Degussa, Tintoria Piana

**Payback:** within 2 years

## High-Fixation Reactive Dyeing with Reduced Salt

Reactive dyes account for over 70% of the dyes used for cotton. Large quantities of salt are needed to exhaust the reactive dyes onto the cotton, and the fixation rate for reactive dyes is often less than 80%, resulting in waste of dye. Removing the unfixed dye requires time, water, and energy in post-dyeing steps. Dye suppliers are now offering improved dyes (often proprietary) that enable much higher exhaustion with lower salt use (less than half the salt required with standard reactive dyes) and higher fixation rates (85% to 90%). These products usually incorporate two reactive groups, such as vinyl sulfones or chlorotriazines. Some vendors are offering a new alkali chemistry to boost fixation and reduce salt.

**Environmental Footprint Reduction**

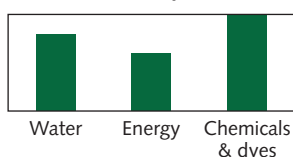

**Industry Survey Response**

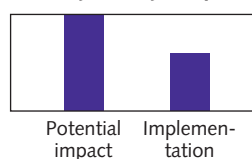

### Commercial Operating Experience

Much progress has been made in commercializing higher-fixation reactive dyes for dyeing yarns, wovens, knits, and garments. Some mills have been able to boost their average fixation rates from below 70% to over 85%. Fixation rates over 90% have been reported.



However, these higher-value dyes often are more expensive than conventional dyes, and mills may not be confident that the dyes will pay for themselves through savings in dyes, chemicals, water, and energy. Implementation should increase significantly as mills gain further experience and confidence that these new dyes do deliver savings in WEC reduction and mill cost.

These dyes have higher affinity for cotton fibers than conventional reactive dyes, which can make it more difficult to achieve level dyeing. Because of their high substantivity, more water may be required for removal of hydrolyzed dye. Salt requirements have been reduced, but more progress is needed.

**Investment:** less than \$200,000

**Payback:** within 2 years

**Vendors:** Anoky, Huntsman

## Enzyme Treatment

Enzymes have found a major role in the textile processing of cotton, from desizing, scouring, and bleaching to special effects and wet finishing. Industry experience with enzymes has grown rapidly in the past 10 years, promoted by ongoing research and development.

**Environmental Footprint Reduction**

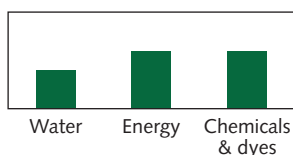

**Industry Survey Response**

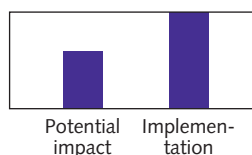

### Commercial Operating Experience

Enzyme technology is being used widely, in most mills and in various applications. The technology is being applied to all textile forms and in most types of processing equipment, both continuous and batch. Mills have reported savings in water, time, chemicals, and energy, as well as in achievement of special product effects.

The most widespread use of enzymes is in desizing, but scouring with enzymes is gaining favor with the industry. Because enzyme scouring will not remove all of the natural oils and waxes that a conventional scour removes, it leaves the fabric somewhat yellow. This is acceptable for fabric that will be dyed in medium to heavy shades. Furthermore, enzyme-scoured fabrics usually have a better hand.

Enzyme technology is being used to some extent in finishing, especially for removal of surface fibers from denim dyed with indigo, to mimic the look of stonewashing, or to destroy the indigo dye, for a bleaching effect. Use of enzymatic treatment in place of stonewashing can reduce solid effluent.

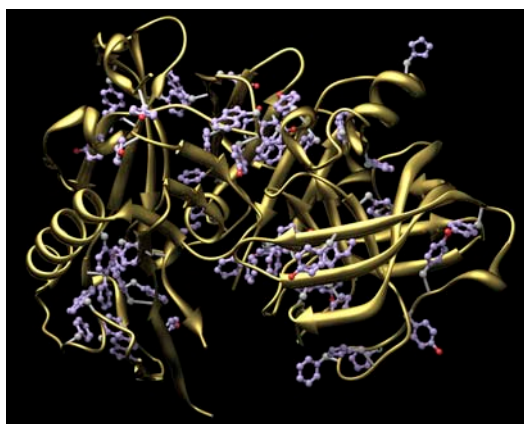

Enzymes are also used on knit fabrics and yarns in a process referred to as “bio-polishing,” to remove short fibers that contribute to surface fuzz, which affects the appearance of garments and contributes to a perception of color loss. Bio-polishing may reduce fabric strength and weight but will improve the appearance of a garment through repeated home laundering cycles.

**Investment:** less than \$200,000

**Payback:** within 2 years

**Vendors:** Dymatic, Genencor, Huntsman, Novozymes

## Size Recovery and Recycling via Ultrafiltration

Scouring and desizing account for 60% to 65% of the wastewater treatment load for cotton textile processing, and the sizing agent used to prepare warp yarns for weaving accounts for over 10% of total chemical consumption. Starch and most modified starches, which account for over 75% of sizes used, are not readily recovered with available technology. Other sizes, such as water-soluble polyvinyl alcohol (PVA), polyacrylates, carboxymethyl cellulose (CMC), and carboxymethyl starch, can be recovered by currently available commercial ultrafiltration systems and reused. Recovery technology continues to improve. For nonrecoverable sizes, some progress is being made in using the size-containing sludge from the wastewater treatment system as fuel.

**Environmental Footprint Reduction**

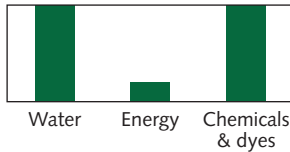

**Industry Survey Response**

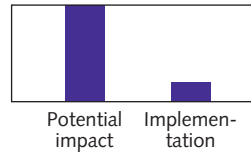

### Commercial Operating Experience

Some large cotton textile mills around the world have successfully implemented ultrafiltration systems for size recovery and reuse. Although recovery and reuse of size shows great promise for reducing the environmental impact of cotton textile processing, industry adoption of recovery systems has not reached its full potential. Economics and environmental regulations that provide incentive for implementation of size recovery and recycling vary from region to region.

One challenge to implementing size recovery and recycling is the common use of nonvertical, nonintegrated processing systems, where the wet-processing mill receives the sized fabric from a separate weaving mill, often located elsewhere. The operator of the wet-processing mill may not even know what size is used on the fabric, nor have a way to return recovered size to a weaving mill for reuse. Nonintegrated mills must solve both the system/management issue and the process engineering issue. Fully integrated mills face less of a challenge.

Unlike biodegradable sizes (such as starch), water-soluble nonbiodegradable sizes (such as PVA and CMC) do not increase the biological oxygen demand load on wastewater treatment. However, they do enter downstream waterways, so mills should make every effort to remove this material from the waste streams at the plant level.



**Investment:** over \$500,000

**Payback:** over 5 years

**Vendors:** Fong's FWT, Koch, Siemens

## Pre-reduced Liquid Dyes

Sulfur dyes, indigo dyes, and other vat dyes must be solubilized by reduction chemistry before being applied to the textile substrate. Reduction is followed by an oxidation process to re-form the pigment *in situ* and develop the final color. Dye suppliers have developed offerings of pre-reduced liquid colorants for these applications, which provide significant environmental advantages for mills. Problems of handling the reducing agents, controlling the reduction process, and managing the reaction byproducts (such as hydrogen sulfide) are avoided, and WEC savings are realized.

**Environmental Footprint Reduction**

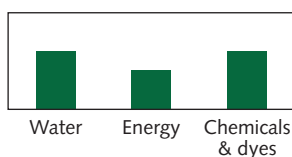

**Industry Survey Response**

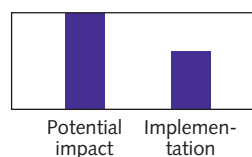

### Commercial Operating Experience

This technology is widely adopted, especially for indigo dyeing of denim fabrics. Mill experience has been good, and WEC reductions have been achieved.

Sulfur dyes, indigo dyes, and other vat dyes account for 20% to 25% of dyes used for cotton textiles. Adoption of pre-reduced liquid dyes to replace conventional mill-based reduction processing is expected to continue. Best handling practices for these liquid dyes may require capital investment in metering and monitoring systems for process control and lot-to-lot repeatability.

Additional reductions in WEC may be achievable through the use of alternative reduction chemistry, such as sodium borohydride, which can be more efficient than sodium hydrosulfite and have less impact on water quality in terms of biological and chemical oxygen demand and total dissolved solids.



**Investment:** less than \$200,000 to \$500,000

**Payback:** 2 to 5 years

**Vendors:** Clariant, DyStar, Montgomery Chemicals

## Pigment Pad Application

Advances in the manufacture of pigments, which are processed into small particle sizes, together with improvements in pigment support chemistries, have greatly improved the appearance and fastness of these dyes. Furthermore, significant advances in finishing technology allow pigment padding and resin application to be combined, producing excellent results in shades up to medium depths for woven fabrics. This system is attractive because no steam fixation or after-washing is required following color application.

### Environmental Footprint Reduction

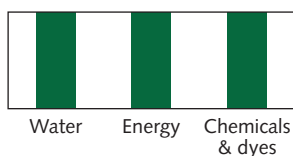

### Industry Survey Response

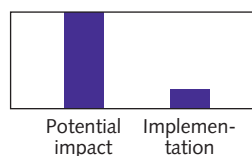

### Commercial Operating Experience

This technology is used in high-volume applications, especially for pale shades and where softness and color-fastness requirements are less stringent. However, the technology has advanced to the point where it should be seriously considered for many other applications.

Successful implementation of this combined dye/finish process requires the following equipment:

- dye pad or foam applicator for recipe application
- infrared pre-dryer
- multizone tenter frame

Included in a typical recipe:

- pigment dyes of choice
- a pigment binder
- a special antimigrant system
- a compatibilizing surfactant system
- DMDHEU resin
- finishing softeners
- a resin catalyst system



The very high potential environmental and cost benefits should promote expanded opportunities to apply this technology in end uses outside conventional pigment applications.

**Investment:** \$200,000 to over \$500,000

**Payback:** 2 to 5 years

**Vendors:** *Chemicals:* BASF, DyStar

*Equipment:* Benninger, Erbatech, Gaston Systems, Goller, Monforts, Morrison



# Equipment

Low-Liquor-Ratio Jet Dyeing Machines

Low-Liquor-Ratio Package Dyeing

Caustic Recovery and Reuse

Insulation of Dyeing, Drying, and Tenter Machines

Solar Heating of Water



## Low-Liquor-Ratio Jet Dyeing Machines

Jet dyeing machines typically are based on the principle of accelerating water through a venturi constriction (or nozzle) to transport fabrics. They are designed to operate efficiently and at high quality with a very low ratio of water to material. In addition to dyeing, these machines are used for preparation and other wet-processing steps. Jet dyeing machines have been used commercially for 40 years. Machines of newer designs operate at a liquor ratio of less than 8:1. These machines usually incorporate low-friction Teflon internal coatings and advanced spray systems to speed rinsing. “Ultra low liquor ratio” jet dyeing machines operate at a liquor ratio of less than 6:1 and almost always depend on forced airflow to convey the fabric through the machine.

**Environmental Footprint Reduction**

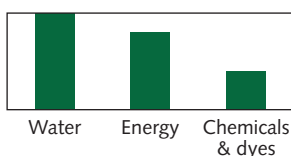

**Industry Survey Response**

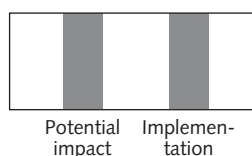

### Commercial Operating Experience

Low-liquor-ratio (LLR) jet dyeing is widely used in high volume for piece-dyed knits, as well as some wovens, depending on fabric weight. Compared with conventional higher-liquor-ratio machines, LLR machines usually enable reduced cycle times and increased productivity, while requiring less than half as much water:

- Some plants achieve four batches in 24 hours (depending on depth of shade).
- Some plants achieve real average water consumption of less than 50 liters per kilogram of knit fabric.
- Some plants using the newest airflow technology machines report processing with liquor ratios of less than 4:1.

One factor limiting implementation is the high cost of the new machines, which favors use at new facilities rather than as replacements for older machines. In addition, it can be difficult to achieve uniformity through the fabric with some shades (such as khaki, olive, or beige).



**Investment:** \$200,000 to \$500,000

**Payback:** 2 to 5 years

**Vendors:** Fong's, Sclavos, THEN, Thies

## Low-Liquor-Ratio Package Dyeing

For package dyeing, liquor ratios of 8:1 are common. State-of-the-art yarn package dyeing technology enables reduction of the liquor ratio to less than 6:1. This can be achieved either with new machines or through retrofitting of existing machines. These LLR machines use more sophisticated liquor circulation systems to promote levelness and repeatability.

**Environmental Footprint Reduction**

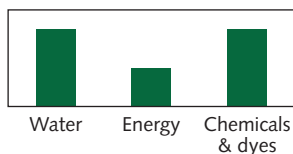

**Industry Survey Response**

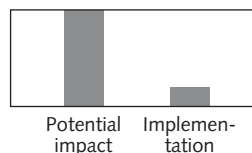

### Commercial Operating Experience

A number of mills have reported achieving liquor ratios of less than 6:1, both with new machines and with retrofitted machines. Specific retrofitting designs are proprietary.

LLR machines can shorten process time significantly, by reducing fill time and the volume of water to be heated. Water and energy consumption can thus be reduced by up to 40%. Lower water levels also result in reduced use and discharge of chemicals.



**Investment:** \$200,000 to \$500,000

**Payback:** 2 to 5 years

**Vendors:** Erbatech, Fong's, Loris Bellini, OBEM, THEN, Thies

## Caustic Recovery and Reuse

This technology involves (1) multi-stage evaporation to concentrate the caustic solution and (2) filtration to clean the caustic solution for reuse. Conventional rotary filters or more advanced microfilters may be used, depending on requirements for the recovered caustic solution. Other approaches to reusing residual caustic include the following:

- Using the weak caustic stream to adjust pH in non-process water (for example, in wastewater treatment) or to neutralize combustion gases.
- Selling waste or weak caustic solutions to outside manufacturers (such as electroplating operations).

**Environmental Footprint Reduction**

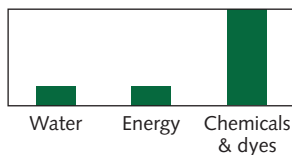

**Industry Survey Response**

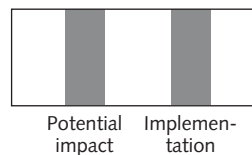

### Commercial Operating Experience

This technology is commercially proven and used widely in processing of yarn, knits, and wovens. Some mills have successfully recovered and reused over 80% of caustic.

Recovery is most successful from the mercerization range if mercerization is performed after bleaching, because fewer contaminants are present. For denim processing applications, improvements are needed to optimize the technology to deal with the indigo present in the waste caustic stream.

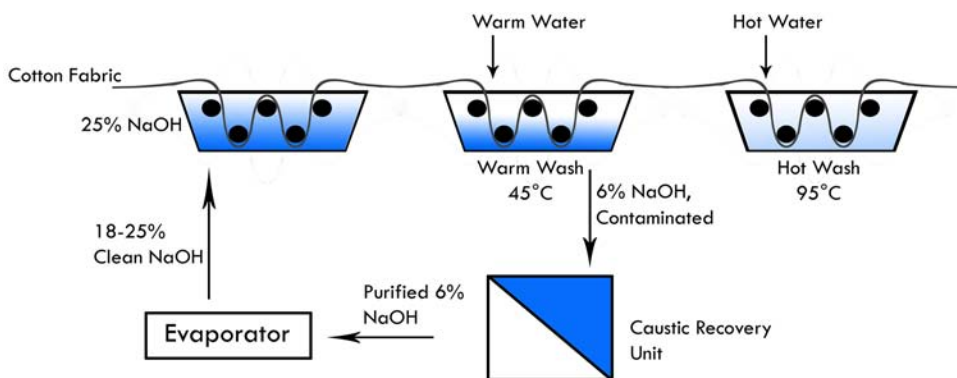

**Investment:** \$200,000 to \$500,000

**Payback:** 2 to 5 years

**Vendors:** Koch

## Insulation of Dyeing, Drying, and Tenter Machines

State-of-the-art dyeing machines and dryers are insulated for energy-efficiency. Older heated machines can be covered with low-thermal-conductivity coatings, foam, or board materials. Many varieties of materials are available from the chemical industry and have been adapted to textile machines. Many of these materials and coatings also provide corrosion resistance, for longer machine life. Technological advances have enabled efficient and effective application of sprayed-on insulating materials to almost any processing equipment or piping system.

**Environmental Footprint Reduction**

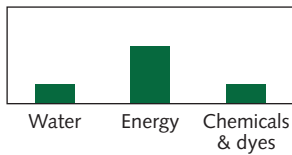

**Industry Survey Response**

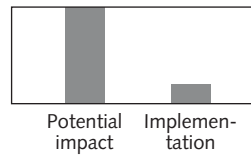

### Commercial Operating Experience

This technology has been used for decades in chemical industries of all types and can be applied in many mill applications and with many types of textile-processing equipment. Operating costs typically are decreased by 5% to 10%.

Insulation is especially effective with jet and other batch wet-processing machines that operate for long periods at high temperatures.



**Investment:** less than \$200,000 to over \$500,000

**Payback:** within 1 year to 5 years

**Vendors:** Brückner,  
Monforts, Strahm

## Solar Heating of Water

Solar heating panels are widely available for commercial installations, for both horizontal and vertical surfaces. The technology is well established and is undergoing another generation of improvement for higher efficiency and lower cost.

**Environmental Footprint Reduction**

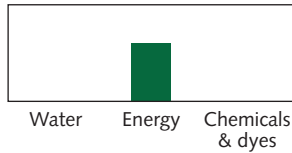

**Industry Survey Response**

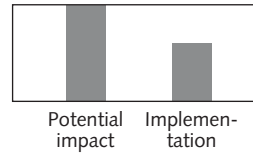

### Commercial Operating Experience

Solar heating is already widely used, in both home and commercial installations, in some major textile manufacturing countries and regions, including China and Turkey. Solar heating is commonly used in wet-processing mills as a first stage, to preheat process water.

To be effective, solar heating requires a large collector surface area. An emerging solar-energy technology involves embedding heat exchangers in parking-lot asphalt.



**Investment:** less than \$200,000 to over \$500,000

**Payback:** 2 to 5 years

**Vendors:** Hetai Industry, Zhejiang Sopray Solar



# **Systems, Control & Management**

**Automatic Dye and Chemical Dispensing**

**Advanced Equipment and Process Control**

**Various System Approaches to Reduce WEC**

**Empowered Environmental Teams**



## Automatic Dye and Chemical Dispensing

This technology involves automatic and semi-automatic weighing, dissolving, and measuring systems for precise delivery of textile chemicals and dyes to production machines, as well as to laboratory machines for shade and sample development. Systems are available for dispensing of both liquid and powder chemicals and dyes. Mills can choose various levels of automation, from quantitative dispensing systems for preparation chemicals and/or dyes to simpler semi-automatic addition systems for manually prepared solutions.

**Environmental Footprint Reduction**

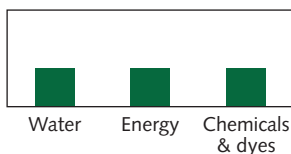

**Industry Survey Response**

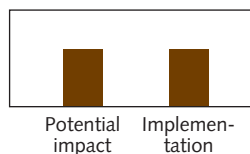

### Commercial Operating Experience

Fully automatic dispensing systems are most common in laboratories, for color development and sample preparation. In mills, semi-automatic addition systems are more common, but automatic dispensing systems are used in larger and more modern mills, especially for batch dyeing of yarns and knits.

These systems improve the accuracy of material additions and the consistency of production, while reducing waste in dyes and chemicals and in off-standard products. Automation of dyes and chemical dispensing can significantly improve Right First Time performance, as well as lot-to-lot shade reproduction.



**Investment:** less than \$200,000 to \$500,000

**Payback:** 2 to 5 years

**Vendors:** Bespoke, KD Associates, Kuans Micro-Auto

## Advanced Equipment and Process Control

Advanced automatic control strategies and systems can be incorporated into metering and application of chemicals and dyes to flat goods, as well as machine rate control and temperature profile control for preparation, dyeing, drying, and finishing operations. These systems can also be used to track pH, water flow, and energy (steam) use, to store procedures, and to track changes, to enhance reproducibility of processes.

**Environmental Footprint Reduction**

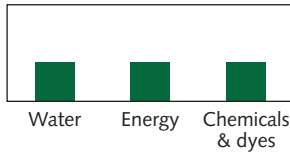

**Industry Survey Response**

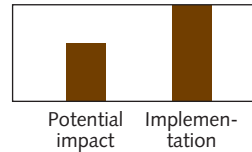

### Commercial Operating Experience

Mills that have applied improved control technology, from basic control implementation and maintenance to more sophisticated advanced process control, have reported reduced cost and WEC consumption, along with substantial gains in productivity and quality:

- Simple controllers, such as retrofitted frequency controllers on motors, provide attractive cost reductions and returns on investment. Many mills have already installed frequency controllers that can reduce energy consumption by over 25%.
- Advanced controls, based on microprocessors that enable feedback control of most process parameters (including pH, temperature, flow rate, and concentrations), offer enhanced control over all mill processes.

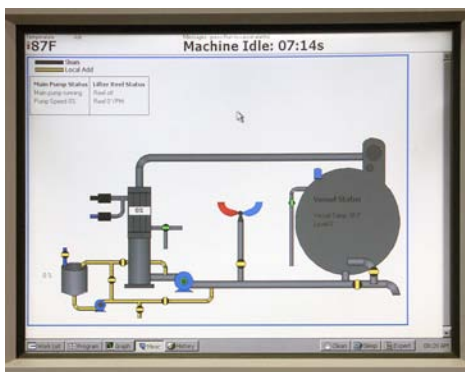

Individually, process control improvements may provide relatively low WEC and cost reduction, but in aggregate, they make significant contributions, typically with high financial return and quick payback. Mill investment includes both initial installation and ongoing maintenance of the controllers. Most of these advanced control technologies usually are preinstalled in new equipment.

Although process measurement and control capability has been well established in a wide range of commercial applications, the benefits need to be evaluated in specific targeted situations.

**Investment:** \$200,000 to \$500,000

**Payback:** within 2 years to 5 years

**Vendors:** Adaptive Control

## Various System Approaches to Reduce WEC

A number of mills have reported applying various system concepts to substantially reduce consumption of water, energy, and chemicals. The examples listed here generally require low to moderate investment to recover heat from water or air streams or simply to adopt a new approach to material handling.

**Environmental Footprint Reduction**

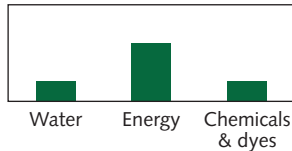

**Industry Survey Response**

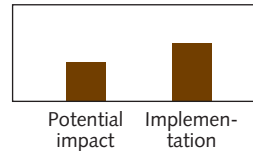

### Commercial Operating Experience

- A number of mills have reported fairly simple retrofitting of piping and installation of heat exchangers to recover and reuse heat from exhaust air streams and waste process water.
- Mills have reported using weak and waste alkali streams to adjust pH in wastewater treatment and to neutralize acidic combustion gases. Others have found opportunities to sell weak alkali solutions to outside businesses in the local area (such as electroplating operations).
- Denim mills are using ultrafiltration systems to recycle indigo from residual baths.
- Mills in China and India have reported using biofuels and eco-fuels for boilers, and some have reported selling sludge from wastewater treatment as a fuel.
- Some mills have developed opportunities to sell coal ash as a component of concrete, and some use it themselves for this purpose. This application is approved in the United States by the Concrete Manufacturers Association.



**Investment:** less than \$200,000 to \$500,000

**Vendors:** Benninger, Monforts, Strahm

**Payback:** within 2 years to 5 years

## Empowered Environmental Teams

Teams of technical, supervisory, and operating personnel are established to drive improvement in the operation's performance, costs, and product quality. Environmental improvements to reduce water, energy, and chemical consumption can be set as a special focus. Teams can also identify frequently occurring breakdowns in the process and prioritize addressing them. Teams can reach out for the expertise required to develop long-term solutions to these breakdowns, and recommend investment as required.

### Environmental Footprint Reduction

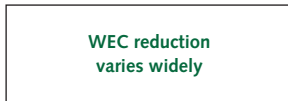

### Industry Survey Response

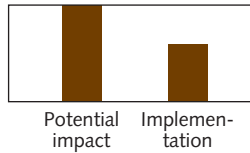

### Commercial Operating Experience

This approach to reducing WEC consumption is being used successfully in many mills, from small to very large and across all textile-manufacturing segments. It has been used to steadily improve product quality against rising customer standards and to reduce waste and costs against rising production standards.

This approach appears to be most effective in identifying opportunities requiring smaller investments, where final decisionmakers are close to the teams, and the teams have strong and consistent management support.

Implementation of training programs such as Six Sigma Black Belt can greatly enhance the effectiveness of these teams.



**Investment:** less than \$200,000

**Payback:** within 1 or 2 years



# Wastewater Treatment

High-Technology Filtration Systems

Recycling of Internal Process Water

Use or Sale of Wastewater Treatment Sludge for Fuel

Physical, Biological, and Activated-Carbon Systems



## High-Technology Filtration Systems

Conventionally, water coming into a textile manufacturing plant is filtered to remove contaminants. Significant water savings can be achieved through the use of advanced filtration systems to filter and recycle wastewater, in both industrial and municipal wastewater treatment plants. These systems are based on the appropriate use of high-technology micro, ultra, nano, and reverse-osmosis filters. Systems are designed for the specific fine particles, molecules, ions, or pathogens that must be removed. Most installations use stages of filters, each with finer porosity, to selectively remove materials.

**Environmental Footprint Reduction**

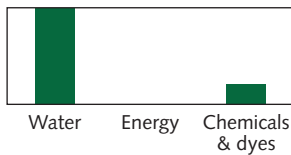

**Industry Survey Response**

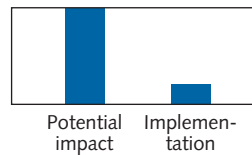

### Commercial Operating Experience

High-technology filtration systems are commercially proven to meet a wide range of filtration requirements. Applications include ultrafiltration for size recovery;



ultrafiltration and reverse osmosis for bleaching and scouring process streams; ultrafiltration and evaporation for mercerizing streams; and ultrafiltration and reverse osmosis for dyeing streams.

Depending on technology used, up to 95% of water can be recycled, and zero discharge is considered feasible. Some high-technology filter systems offer self-cleaning capability, to extend the life of the filter.

Current installations typically are in regions where water availability is restricted or increasingly threatened.

**Investment:** \$200,000 to over \$500,000

**Payback:** within 1 year to 10 years

**Vendors:** Benninger, Fong's FWT, Koch, Lenntech, Siemens

## Recycling of Internal Process Water

Water currently discarded after one use can be re-piped into process vessels for reuse one or more times. The recycle stream can be used directly, with or without dilution with fresh water. Recycling of water can also be combined with recycling of heat.

**Environmental Footprint Reduction**

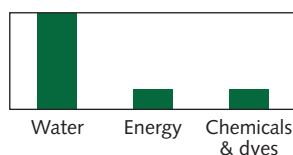

**Industry Survey Response**

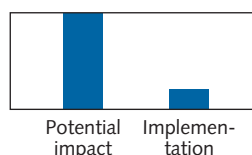

### Commercial Operating Experience

Recycling of internal process water has been commercially proven in many plants. For example, in-plant water recycling has been used for these purposes:

- Counter-flowing water from the last washboxes to the first washboxes of a continuous range.
- Capturing water from bleach rinsing to use as make-up water to reconstitute the bleach bath. This allows recovery of caustic and surfactant, thus saving water and chemicals. (A holding tank may be required.)
- Recovering the heat from recycled process water by means of heat exchangers.

Successful implementation of in-plant water recycling may require some additional adjustments:

- Process adjustments to accommodate the use of less-pure water.
- Chemical neutralizations or pH control.
- Additional product quality checks.
- Monitoring of discharge water for color and for biological and chemical oxygen demand.



**Investment:** less than \$200,000 to \$500,000

**Payback:** within 1 year to 5 years

**Vendors:** Benninger, Koch

## Use or Sale of Wastewater Treatment Sludge for Fuel

Dry sludge retrieved from the wastewater treatment facility can be consolidated and burned in the plant boiler. In addition, local markets for sludge as fuel are growing in both developing and developed economies.

Environmental Footprint Reduction

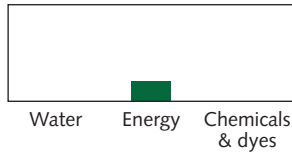

Industry Survey Response

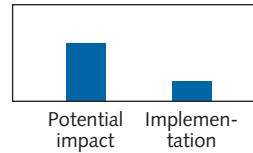

### Commercial Operating Experience

Use of sludge from wastewater treatment is increasing in China and India. Sales or use of sludge for fuel typically more than offset the added costs for consolidation and retrieval.

Use of sludge as fuel requires certain environmental precautions:

- Release of emissions-restricted gases into the atmosphere must be avoided.
- The sludge must be free of metals, to avoid release of metal oxides or other hazardous by-products.
- Stack gas filters or segregation of some chemicals from the sludge may be required.



**Investment:** less than \$200,000

**Payback:** within 1 year

## Physical, Biological, and Activated-Carbon Systems

Current individual plant, industrial park, or community wastewater and sludge treatment installations can be upgraded with additional processing steps based on physical, biological, and activated-carbon technologies. These technologies are well established and can be engineered and sized to the specific requirements of the effluent streams.

### Environmental Footprint Reduction

No WEC savings, but improves quality of water returned to the environment

### Industry Survey Response

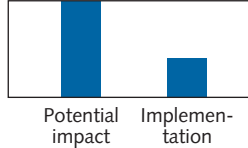

### Commercial Operating Experience

These technologies are used broadly in a wide variety of municipal and industrial venues and applications, and are applicable to all textile manufacturing installations. They reduce color, toxicity, chemical oxygen demand, and biological oxygen demand of water returned to the environment.

Commercially available technologies include the new anaerobic/aerobic biomass degradation systems.



**Investment:** \$200,000 to \$500,000

**Payback:** 2 to 5 years

**Vendors:** Fong's FWT, Koch, Lenntech



# Summary Chart

**Applicability to Yarn, Knits, Wovens, and Denim**

**Potential Impact on WEC Reduction**

**Estimated Investment and Payback Time**

**Key to Chart—WEC reduction:**

- = high *or* moderate to high
  - ◐ = moderate *or* low to moderate
  - = low
- 

Technology (page)	Yarn	Applicability		
		Knits	Wovens	Denim
<b>Process</b>				
Cold Pad Batch Preparation and Dyeing (5)		✓	✓	
Continuous Processing of Knits (6)		✓		
Two-Stage Preparation of Wovens (7)			✓	
Combined Scour and Bleach for Yarns and Knits (8)	✓	✓		
Foam Dyeing, Finishing, and Coating (9)		✓	✓	✓
Pad/Dry vs. Pad/Dry/Pad/Steam (10)		✓	✓	
Right First Time Dyeing (11)	✓	✓	✓	✓
<b>Chemicals and Dyes</b>				
Cationization for Salt-Free Dyeing (15)	✓	✓	✓	
High-Fixation Reactive Dyeing with Reduced Salt (16)	✓	✓	✓	
Enzyme Treatment (17)		✓	✓	✓
Size Recovery and Recycling via Ultrafiltration (18)			✓	✓
Pre-reduced Liquid Dyes (19)	✓	✓	✓	✓
Pigment Pad Application (20)		✓	✓	
<b>Equipment</b>				
Low-Liquor-Ratio Jet Dyeing Machines (23)		✓	✓	
Low-Liquor-Ratio Package Dyeing (24)	✓			
Caustic Recovery and Reuse (25)	✓	✓	✓	✓
Insulation of Dyeing, Drying, and Tenter Machines (26)	✓	✓	✓	✓
Solar Heating of Water (27)	✓	✓	✓	✓
<b>Systems, Control, and Management</b>				
Automatic Dye and Chemical Dispensing (31)	✓	✓	✓	✓
Advanced Equipment and Process Control (32)	✓	✓	✓	✓
Various System Approaches to Reduce WEC (33)	✓	✓	✓	✓
Empowered Environmental Teams (34)	✓	✓	✓	✓
<b>Wastewater Treatment</b>				
High-Technology Filtration Systems (37)	✓	✓	✓	✓
Recycling of Internal Process Water (38)	✓	✓	✓	✓
Use or Sale of Wastewater Treatment Sludge for Fuel (39)	✓	✓	✓	✓
Physical, Biological, and Activated-Carbon Systems (40)	✓	✓	✓	✓

## Summary

Potential WEC Reduction				
Water	Energy	Chemicals	Investment	Payback
●	●	●	> \$500K	2 to 5 years
●	●	●	> \$500K	2 to 5 years
●	◐	◐	< \$200K to > \$500K	< 2 to > 5 years
●	●	◐	< \$200K	< 2 years
●	●	◐	> \$500K	2 to 5 years
●	●	●	> \$500K	> 5 years
●	●	●	< \$200K	< 2 years
◐	◐	●	< \$200K	< 2 years
●	◐	●	< \$200K	< 2 years
◐	◐	◐	< \$200K	< 2 years
●	○	●	> \$500K	> 5 years
◐	◐	◐	< \$200K to \$500K	2 to 5 years
●	●	●	\$200K to > \$500K	2 to 5 years
●	●	◐	\$200K to \$500K	2 to 5 years
●	◐	●	\$200K to \$500K	2 to 5 years
○	○	●	\$200K to \$500K	2 to 5 years
○	◐	○	< \$200K to > \$500K	< 1 to 5 years
	◐		< \$200K to > \$500K	2 to 5 years
◐	◐	◐	< \$200K to \$500K	2 to 5 years
◐	◐	◐	\$200K to \$500K	< 2 to 5 years
○	◐	○	< \$200K to \$500K	< 2 to 5 years
Varies widely			< \$200K	< 1 to 2 years
●		○	\$200K to > \$500K	< 1 to 10 years
●	○	○	< \$200K to \$500K	< 1 to 5 years
	○		< \$200K	< 1 year
Improves quality of water returned			\$200K to > \$500K	2 to 5 years

## Vendors

### **Adaptive Control Inc.**

9801 West Kincey Avenue, Suite 190  
Huntersville NC 28078  
USA  
Tel +1-704-947-0770  
Fax +1-704-947-6200  
sales@adaptivecontrol.com  
www.adaptivecontrol.com

### **Anoky Textile Chemicals Co., Ltd.**

No. 881, Songhua Road  
Qingpu District  
Shanghai 201700  
China  
Tel +86-21-5986-7366  
Fax +86-21-5986-7355  
www.anoky.com.cn

### **BASF Corporation**

#### **Performance Chemicals RBU**

4330 Chesapeake Drive  
Charlotte, NC 28216  
USA  
Tel +1-704-392-4313  
Fax +1-704-394-8336

#### **BASF Global**

Carl-Bosch-Straße 38  
67056 Ludwigshafen  
Germany  
Tel +49-621-60-0  
Fax +49-621-60-42525  
global.info@basf.com  
www.basf.com

### **Benninger AG**

Frabrikstraße  
CH-9240 Uzwil  
Switzerland  
Tel +41-71-955-8585  
Fax +41-71-955-8747  
benswiss@benningergroup.com  
www.benningergroup.com

### **Bespoke Textile Computer Systems**

62 Buxton Road  
Heaviley, Stockport  
SK2 6N3  
United Kingdom  
Tel +44-161-475-3580  
Fax +44-161-476-6084  
sales@bespoke-computers.com  
www.bespoke-computers.com

### **Brückner Technology Holding GmbH**

Königsberger Straße 5-7  
83313 Siegsdorf  
Germany  
Tel +49-8662-63-0  
Fax +49-8662-63-9220  
sales@brueckner.com  
www.brueckner.com

### **CHT R. Beitlich GmbH**

Bismarckstraße 102  
72072 Tübingen  
Germany  
Tel +49-7071-154-0  
Fax +49-7071-154-290  
info@cht.com  
www.cht.com

### **Clariant Corporation**

4000 Monroe Road  
28205 Charlotte, NC  
USA  
Tel +1-704-331-7000  
Fax +1-704-377-1063  
www.clariant.us

### **Dow Chemical Co.**

#### **USA and Canada:**

Tel +1-800-447-4369  
Fax +1-989-832-1465

#### **Europe:**

Tel +800-3-694-6367  
(toll-free from Austria, Belgium, Denmark,  
Finland [prefix 990], France, Germany,  
Hungary, Ireland, The Netherlands, Norway,  
Portugal, Spain, Sweden, Switzerland, U.K.)  
Tel +32-3-450-2240 (toll call)  
Tel +800-783-825 (Italy toll-free)  
Tel +800-99-5078 (South Africa toll-free)  
Fax +32-3-450-2815

#### **Other Global Areas:**

Tel +1-989-832-1560 (USA)  
Fax +1-989-832-1465 (USA)

**Dymatic Chemicals, Inc.**

South Chaogui Road  
Science and Technology Industrial Park  
Foshan New- and High-Tech  
Industrial Development Zone  
Foshan, Guangdong 528305  
China  
Tel +86-757-2839-9088  
Fax +86-757-2839-6930  
info@dymatic.com  
www.dymatic.com

**DyStar Textilfarben  
GmbH & Co. Deutschland KG**

Industriepark Höchst  
65926 Frankfurt am Main  
Germany  
Tel +49-69-2109-0  
Fax +49-69-2109-2000  
dystar.germany@dystar.com  
www2.dystar.com

**Erbatech GmbH**

Werner-von-Siemens-Straße 30  
64711 Erbach  
Germany  
Tel +49-6062-951-0  
Fax +49-6062-951-166  
info@erbatech.com  
www.erbatech.com

**Evonik Degussa GmbH**

Rellinghauser Straße 1-11  
45128 Essen  
Germany  
Tel +49-201-177-01  
Fax +49-201-177-3475  
info-chemicals@evonik.com  
www.degussa.com

**Fong's**

8/F, 22-28 Cheung Tat Road  
Tsing Yi  
Hong Kong  
Tel +852-2497-3300  
Fax +852-2432-2552  
enquiry@fongs.com  
www.fongs.com

**Fong's FWT**

info@fwt.com.hk  
www.fwt.com.hk

**Fong's Water Technology Co., Ltd.**

8/F, 22-28 Cheung Tat Road  
Tsing Yi  
Hong Kong  
Tel +852-2497-3300  
Fax +852-2432-2552

**Fong's Water Technology and Conservation  
Equipment Co., Ltd.**

Rm 511-515, Block A, Hailrun Complex  
Tai Ran Jiu Lu West  
Shen Nan Da Dao, Futian District  
Shenzhen, Guangdong 518040  
China  
Tel +86-755-8345-8970  
Fax +86-755-8204-7016

**Gaston Systems, Inc.**

200 South Main Street  
Stanley, NC 28164-2011  
USA  
Tel +1-704-263-6000  
Fax +1-704-263-0954  
info@gastonsystems.com  
www.gastonsystems.com

**Genencor**

Danisco US Inc., Genencor Division  
200 Meridian Centre Boulevard  
Rochester, NY 14618-3916  
USA  
Tel +1-585-256-5200  
Fax +1-585-256-6952  
genencor@danisco.com  
www.genencor.com

**Goller Textilmaschinen GmbH (Fong's)**

Am Hammeranger 1  
95126 Schwarzenbach/Saale  
Germany  
Tel +49-9284-932-0  
Fax +49-9284-932-102  
info@goller.de  
www.goller.de

**Goller (HK) Limited (Fong's)**

8/F, 22-28 Cheung Tat Road  
Tsing Yi  
Hong Kong  
Tel +852-2449-9280  
Fax +852-2449-9638  
info@goller-hk.com  
www.goller.de

**Hetai Industry**

20 Shashan Road  
Huashi Industrial Area  
Jiangyin, Jiangsu 214421  
China  
Tel +86-510-8640-2701  
Fax +86-510-8640-2707  
info@hetai-industry.com  
www.hetai-industry.com

## Vendors

### **Huntsman Textile Effects**

4050 Premier Drive  
High Point, NC 27265  
USA  
Tel +1-800-822-1736  
www.huntsman.com

### **Innova International, Inc.**

3333 Oak Lake Boulevard  
Charlotte, NC 28208  
USA  
Tel +1-704-357-0328  
Fax +1-704-357-6161  
info@innova-international.com  
www.innova-international.com

### **KD Associates (UK)/**

### **Maintrade House Ltd. (HK)**

Unit D, 10/F, Dragon Center  
79 Wing Hong Street  
Cheung Sha Wan, KLN  
Hong Kong  
Tel +852-2310-8313  
Fax +852-2371-0997  
mth@maintrade.com.hk  
www.maintrade.com.hk

Waterside House, Waterside Lane,  
Holmbridge, Holmfirth  
HD9 2PF  
United Kingdom  
Tel +44-1484-683-116  
Fax +44-1484-683-116  
keithdudleykda@gmail.com  
www.kdadispenser.com

### **Koch Industries, Inc.**

P.O. Box 2256  
Wichita, KS 67201-2256  
USA  
info@kochind.com  
www.kochind.com

### **Kuans Micro-Auto Co., Ltd.**

No.15, Lane 704, Ho Pin Road  
Pateh, Taoyuan-Hsien, 33463  
Taiwan  
Tel +886-3-367-2980  
Fax +886-3-367-2982  
kuans.micro@msa.hinet.net  
www.kuans.com.tw

### **Lenntech Water Treatment and Air Purification Holding B.V.**

Rotterdamseweg 402 M  
2629 HH Delft  
The Netherlands  
Tel +31-15-261-0900  
Fax +31-15-261-6289  
info@lenntech.com  
www.lenntech.com

### **Loris Bellini S.p.A.**

Via XI Febbraio, 26  
20021 Bollate  
Italy  
Tel +39-02-350-5901  
Fax +39-02-350-1665  
info@lorisbellini.com  
www.lorisbellini.com

### **A. Monforts Textilmaschinen GmbH & Co. KG**

Schwalmstraße 301  
41238 Mönchengladbach  
Germany  
Tel +49-2161-401-409  
info@textil.monforts.de  
www.monforts.de

### **Montgomery Chemicals**

901 Conshohocken Road  
Conshohocken, PA 19428  
USA  
Tel +1-706-467-9106  
Fax +1-706-467-3197  
clumsden@montchem.com  
www.montgomerychemical.com

### **Morrison Textile Machinery Co.**

6044 Lancaster Highway  
PO Box 1  
Fort Lawn, SC 29714-0001  
USA  
Tel +1-803-872-4401  
Fax +1-803-872-4443  
mtmco@morrisonetextmach.com  
www.morrisonetextmach.com

### **Novozymes A/S**

Krogshoejvej 36  
2880 Bagsvaerd  
Denmark  
Tel +45-4446-0000  
Fax +45-4446-9999  
www.novozymes.com

**OBEM S.p.A.**

**Dyeing and Steaming Machinery**

Via Brignana, 21  
13900 Biella  
Italy  
Tel +39-015-338-43  
Fax +39-015-252-2307  
www.obem.it

**Sclavos S.A.**

Kormatzini Area  
32009 Shimatari, Viotia  
Greece  
Tel +30-22620-59788  
Fax +30-22620-59787  
info@sclavos.gr  
www.sclavos.gr

**Siemens AG**

Wittelsbacherplatz 2  
80333 Munich  
Germany  
Tel +49-69-797-6660  
(International; English)  
+49-800-225-5336  
(Germany; German)  
contact@siemens.com  
www.siemens.com

**Stork Prints BV**

Raamstraat 1-3  
5831 AT Boxmeer  
The Netherlands  
Tel +31-485-599-555  
Fax +31-485-599-556  
info.storkprints@stork.com  
www.storkprints.com

**Strahm Hi-Tex Systems AG**

Kreuzlingerstraße 5  
CH-8574 Lengwil-Oberhofen  
Switzerland  
Tel +41-71-686-0000  
Fax +41-71-686-0001  
info@strahmts.ch  
www.strahmts.ch

**THEN Maschinen GmbH (Fong's)**

Milchgrundstraße 32  
74523 Schwäbisch Hall, Hessian  
Germany  
Tel +49-791-403-0  
Fax +49-791-403-166  
info@then-gmbh.de  
www.then.de

**Thies AG**

Industriestraße 13  
7304 Maienfeld  
Switzerland  
Tel +41-81-300-4131  
Fax +41-81-300-4132  
info@thiestextilmaschinen.ch  
www.thiestextilmaschinen.ch

**Tintoria Piana U.S., Inc.**

220 South Erwin St  
Cartersville, GA 30120  
USA  
Tel +1-770-382-1395  
Fax +1-770-382-6457  
info@tintoriapiana.com  
www.tintoriapiana.com

**Zhejiang Sopray Solar Co. Ltd**

Yilida Road  
Hengjie, Luqiao District  
Taizhou, Zhejiang 318058  
China  
Tel +86-576-8295-8199  
Fax +86-576-8275-5666  
solarlight@globalsources.com  
www.globalsources.com/solarlight.co



## **COTTON INCORPORATED WORLDWIDE OFFICES**

Visit our web site  
at **[www.cottoninc.com](http://www.cottoninc.com)**

### **World Headquarters**

6399 Weston Parkway  
Cary, NC 27513  
USA  
Tel +1-919-678-2220  
Fax +1-919-678-2230

### **Mexico City**

Av. Insurgentes Sur 1605-9-C  
Col. San José Insurgentes  
03900 Benito Juárez, México, D.F.  
Mexico  
Tel +52-55-5663-4020  
Fax +52-55-5663-4023

### **Osaka**

Mengyo Kaikan Shinkan 6F  
5-8, Bingo-machi 2-chome  
Chuo-ku, Osaka 541-0051  
Japan  
Tel +81-6-6223-0100  
Fax +81-6-6223-0600

### **Consumer Marketing Headquarters**

488 Madison Avenue  
New York, NY 10022  
USA  
Tel +1-212-413-8300  
Fax +1-212-413-8377

### **Hong Kong**

Suite 2007, Tower 6, The Gateway  
9 Canton Road, Tsimshatsui  
Kowloon  
Hong Kong  
Tel +852-2175-5321  
Fax +852-2175-5110

### **Shanghai**

Unit 2309 & 2310, Plaza 66  
1266 Nanjing Road (W)  
Shanghai 200040  
China  
Tel +86-21-6288-1666  
Fax +86-21-6288-3666



® The Seal of Cotton  
is a registered trademark  
of Cotton Incorporated.